

---

# TPMC872

## One / two Socket PC Card Interface

Version 1.0

### User Manual

Issue 1.0

March 2004

---

**TEWS TECHNOLOGIES GmbH**

Am Bahnhof 7  
Phone: +49-(0)4101-4058-0  
e-mail: [info@tews.com](mailto:info@tews.com)

25469 Halstenbek / Germany  
Fax: +49-(0)4101-4058-19  
[www.tews.com](http://www.tews.com)

**TEWS TECHNOLOGIES LLC**

1 E. Liberty Street, Sixth Floor  
Phone: +1 (775) 686 6077  
e-mail: [usasales@tews.com](mailto:usasales@tews.com)

Reno, Nevada 89504 / USA  
Fax: +1 (775) 686 6024  
[www.tews.com](http://www.tews.com)

### TPMC872-10

**One Socket PC Card Interface**, inserted PC Card accessible through PMC front panel

### TPMC872-11

**One Socket PC Card Interface**, inserted PC Card aligned with PMC board border, no front panel

### TPMC872-12

**One Socket PC Card Interface**, inserted PC Card aligned with PMC board border, with PMC front panel

### TPMC872-20

**Two Socket PC Card Interface**, inserted PC Card in first socket accessible through PMC front panel. The second socket is relegated so that the inserted card is located behind the PMC board border.

### TPMC872-21

**Two Socket PC Card Interface**, inserted card in first socket is aligned with the PMC board border. The second socket is relegated so that the inserted card is located behind the PMC board border, no PMC front panel.

### TPMC872-22

**Two Socket PC Card Interface**, inserted card in first socket is aligned with the PMC board border. The second socket is relegated so that the inserted card is located behind the PMC board border, with PMC front panel.

This document contains information, which is proprietary to TEWS TECHNOLOGIES GmbH. Any reproduction without written permission is forbidden.

TEWS TECHNOLOGIES GmbH has made any effort to ensure that this manual is accurate and complete. However TEWS TECHNOLOGIES GmbH reserves the right to change the product described in this document at any time without notice.

TEWS TECHNOLOGIES GmbH is not liable for any damage arising out of the application or use of the device described herein.

#### Style Conventions

Hexadecimal characters are specified with prefix 0x, i.e. 0x029E (that means hexadecimal value 029E).

For signals on hardware products, an 'Active Low' is represented by the signal name with # following, i.e. IP\_RESET#.

Access terms are described as:

- W Write Only
- R Read Only
- R/W Read/Write
- R/C Read/Clear
- R/S Read/Set

©2004 by TEWS TECHNOLOGIES GmbH

Issue	Description	Date
1.0	First Issue	March 2004

# Table of Contents

<b>1</b>	<b>PRODUCT DESCRIPTION.....</b>	<b>5</b>
	1.1 Module TPMC872-10 (One Socket).....	6
	1.2 Module TPMC872-11 (One Socket).....	7
	1.3 Module TPMC872-12 (One Socket).....	8
	1.4 Module TPMC872-20 (Two Sockets).....	9
	1.5 Module TPMC872-21 (Two Sockets).....	9
	1.6 Module TPMC872-22 (Two Sockets).....	9
<b>2</b>	<b>TECHNICAL SPECIFICATION.....</b>	<b>10</b>
<b>3</b>	<b>FUNCTIONAL DESCRIPTION .....</b>	<b>11</b>
	3.1 Address Mapping TPMC872 – PC Card 16 mode.....	11
	3.1.1 Memory Mapping.....	11
	3.1.2 I/O Mapping .....	12
	3.2 Address Mapping TPMC872 – CardBus mode.....	13
	3.3 PCI Interrupts .....	14
<b>4</b>	<b>PCI1520 PC CARD CONTROLLER .....</b>	<b>15</b>
	4.1 PCI Configuration Registers (Functions 0 and 1).....	15
	4.1.1 PCI Header of the TPMC872 Version 1.0 .....	15
	4.2 Configuration EEPROM.....	16
	4.3 ISA Interrupts .....	17
	4.4 Initialization for CardBus mode.....	18

## Table of Figures

FIGURE 1-1 : BLOCK DIAGRAM TPMC872 .....	5
FIGURE 1-2 : MODULE TPMC872-10.....	6
FIGURE 1-3 : SIDE VIEW OF MODULE TPMC872-10 .....	6
FIGURE 1-4 : MODULE TPMC872-11 .....	7
FIGURE 1-5 : SIDE VIEW OF MODULE TPMC872-11 .....	7
FIGURE 1-6 : MODULE TPMC872-12.....	8
FIGURE 1-7 : SIDE VIEW OF MODULE TPMC872-12 .....	8
FIGURE 1-8 : SIDE VIEW OF MODULE TPMC872-20 .....	9
FIGURE 1-9 : SIDE VIEW OF MODULE TPMC872-21 .....	9
FIGURE 1-10: SIDE VIEW OF MODULE TPMC872-22 .....	9
FIGURE 2-1 : TECHNICAL SPECIFICATION.....	10
FIGURE 3-1 : PCI TO PC CARD MEMORY MAPPING .....	11
FIGURE 3-2 : PCI TO PC CARD I/O MAPPING .....	12
FIGURE 3-3 : CARDBUS WINDOW MECHANISM .....	13
FIGURE 3-4 : SOCKET REGISTERS IMPLEMENTED IN PCI1520 (FUNCTION 0 AND 1) .....	13
FIGURE 4-1 : PCI CONFIGURATION REGISTER .....	15
FIGURE 4-2 : CONFIGURATION EEPROM.....	16
FIGURE 4-3 : ISA INTERRUPTS.....	17
FIGURE 4-4 : ISA IRQ PAD LOCATION.....	17

# 1 Product Description

The TPMC872 is a standard single-width 32 bit PMC module providing one or two sockets for 16 bit PC Card or 32 bit CardBus Cards using a dual socket PC Card / CardBus controller and a power management unit. The first CardBus / PC Card socket is mounted on the component side of the PMC. This socket supports card types I and II. The second PC Card / CardBus socket is mounted on the solder side of the PMC (TPMC872-2x only), supporting card types I, II and III.

The register map of the PC Card controller is Intel 82365-DF compatible.

The power management unit provides 3.3V or 5.0V PC Card / CardBus power supply and 3.3V, 5.0V or 12V PC Card / CardBus programming voltage. Due to the short circuit and thermal protection of the power management unit no external fuses are needed on the module.

The TPMC872 provides full ExCA register implementation for 16 bit PC Cards compatible with PCMCIA 2.1/JEIDA 4.2 standards. Both memory and I/O cards are supported. Up to five memory windows and up to two I/O windows are available for PC Card16 accesses. For 32 bit CardBus cards two memory windows and two I/O windows are supported by the controller. CardBus card status information can be accessed in five card bus socket registers which can be mapped in the host memory space.

**The PC Card assembly has a maximum component height of 5.6mm which is 0.9mm above the specified component height (4.7mm) according to IEEE1386.1. The TPMC872 Version 1.0 will power up in the 16 bit PC Card mode.**

**The second PC Card socket is assembled on the solder side of the PMC, requiring additional space.**

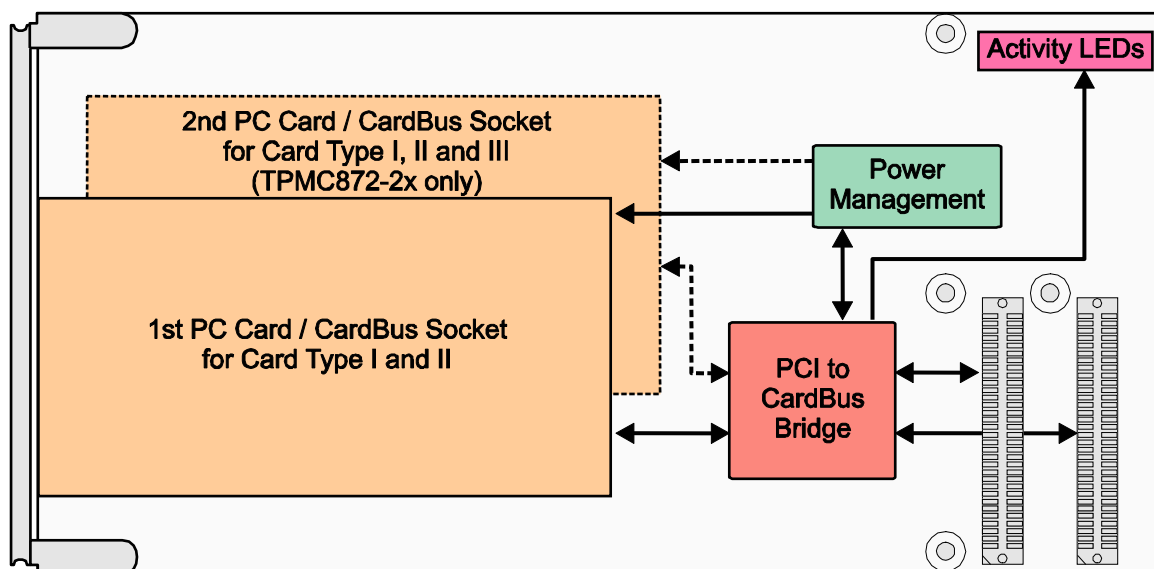

Figure 1-1 : Block Diagram TPMC872

## 1.1 Module TPMC872-10 (One Socket)

The inserted card is accessible through the PMC front panel.

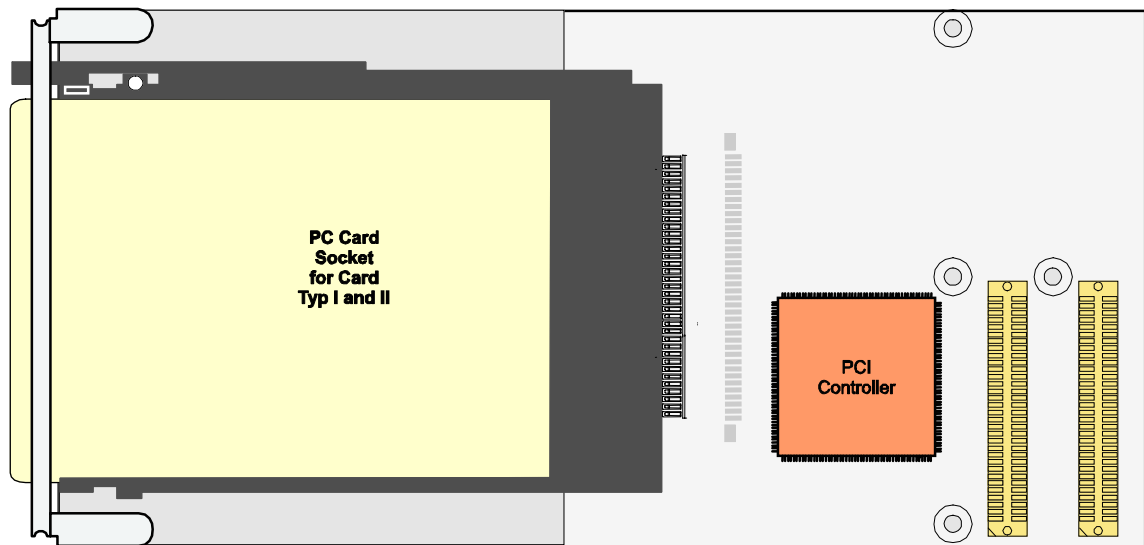

Figure 1-2 : Module TPMC872-10



Figure 1-3 : Side view of Module TPMC872-10

## 1.2 Module TPMC872-11 (One Socket)

The socket is relegated so that the inserted card is aligned with the PMC board border. It has no PMC front panel.

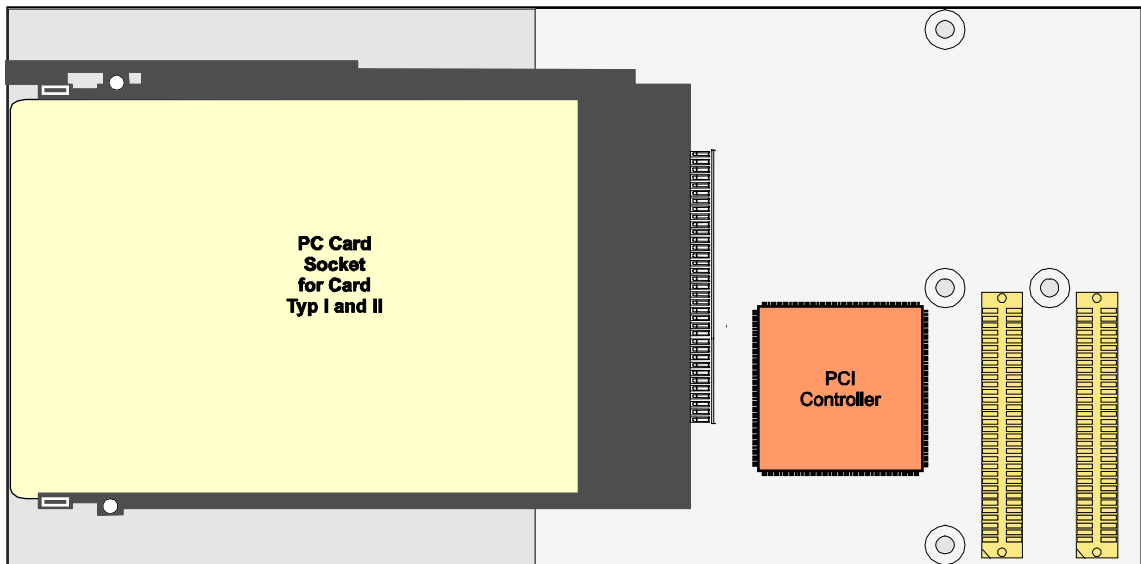

Figure 1-4 : Module TPMC872-11



Figure 1-5 : Side view of Module TPMC872-11

## 1.3 Module TPMC872-12 (One Socket)

The socket is relegated so that the inserted card is aligned with the PMC board border. It has a PMC front panel.

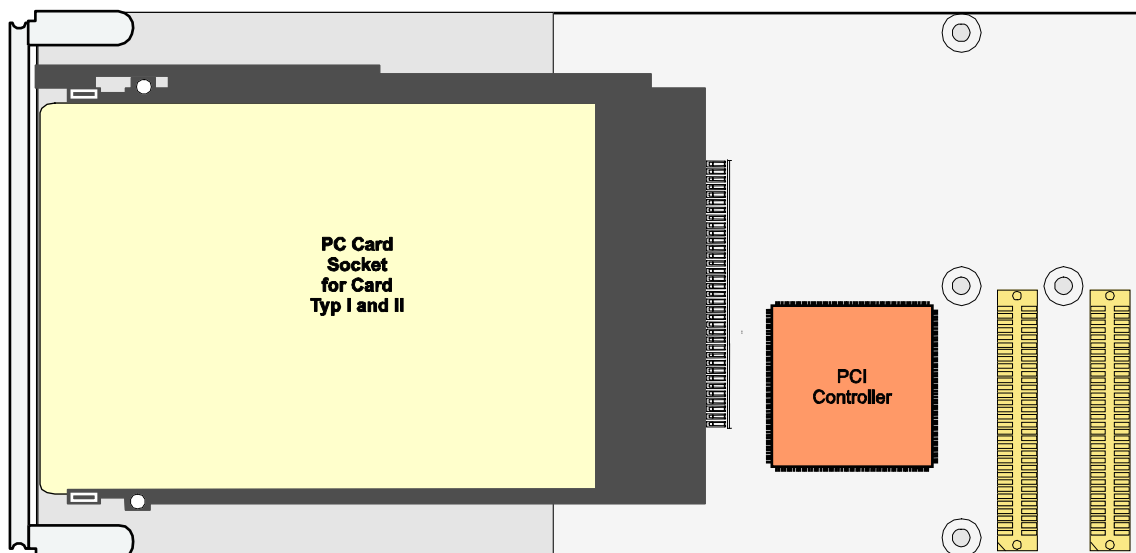

Figure 1-6 : Module TPMC872-12



Figure 1-7 : Side view of Module TPMC872-12

## 1.4 Module TPMC872-20 (Two Sockets)

The inserted card in the first socket is accessible through the front panel. The second socket on the solder side of the PMC is relegated so that the inserted card is located behind the PMC board border.

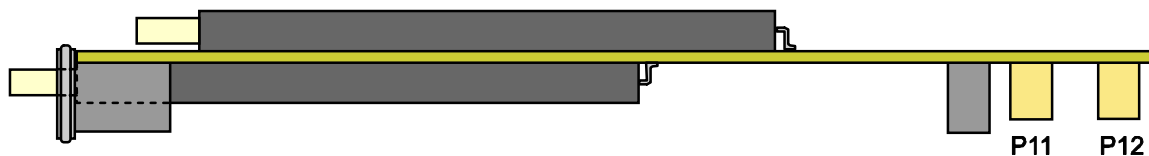

Figure 1-8 : Side view of Module TPMC872-20

## 1.5 Module TPMC872-21 (Two Sockets)

The module has no PMC front panel. The first socket is relegated so that the inserted card is aligned with the PMC board border. The second socket on the solder side of the PMC is relegated so that the inserted card is located behind the PMC board border.

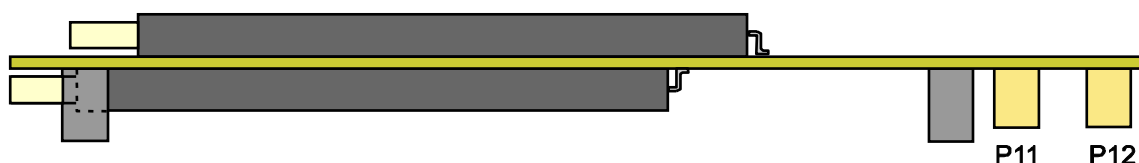

Figure 1-9 : Side view of Module TPMC872-21

## 1.6 Module TPMC872-22 (Two Sockets)

The first socket is relegated so that the inserted card is aligned with the PMC board border. The second socket on the solder side of the PMC is relegated so that the inserted card is located behind the PMC board border. It has a PMC front panel.

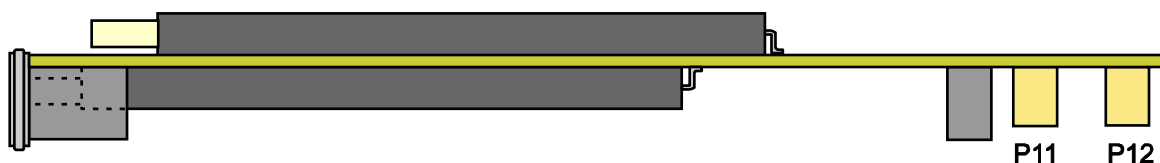

Figure 1-10: Side view of Module TPMC872-22

## 2 Technical Specification

<b>Mechanical Interface</b>	PCI Mezzanine Card (PMC) Interface Single Size	
<b>Electrical Interface</b>	PCI Rev. 2.2 compliant 33 MHz / 32 bit PCI 3.3V and 5V PCI Signaling Voltage	
<b>On Board Devices</b>		
<b>PCI Controller</b>	Texas Instruments PCI1520	
<b>CMC Module</b>	PMC module conforming to IEEE P1386.1 <b>The PC Card assembly has a maximum component height of 5.6mm which is 0.9mm above the specified component height (4.7mm) according to IEEE1386.1.</b> <b>The second PC Card socket is assembled on the solder side of the PMC, requiring additional space.</b>	
<b>Module Specific Data</b>		
<b>PC Card Interface</b>	16 bit PC Card electrical interface 32 bit CardBus electrical interface	
<b>PC Card Sockets</b>	1 socket for card types I and II 1 socket for card types I, II and III (TPMC872-2x only)	
<b>PC Card Operating Voltage</b>	+3.3V or +5V	
<b>PC Card Programming Voltage</b>	+3.3V/+5V or +12V	
<b>PC Card Supply Current</b>	1A maximum per socket	
<b>PC Card Programming Current</b>	100mA maximum per socket	
<b>Physical Data</b>		
<b>Power Requirements</b>	70mA typical @ +3.3V DC 7mA typical @ +5V DC <2mA typical @ V(I/O)	
<b>Power Requirements with PC Card</b>	Voltage and current depends on the used PC Card	
<b>Temperature Range</b>	Operating	-40°C to +85°C
	Storage	-40°C to +85°C
<b>MTBF</b>	638000 h	
<b>Humidity</b>	5 – 95 % non-condensing	
<b>Weight</b>	72 g, no PC Card inserted	

Figure 2-1 : Technical Specification

## 3 Functional Description

The TPMC872 uses a PCI1520 PC Card controller from Texas Instruments to support 16 bit PC Card 16 and 32 bit CardBus Cards. The PCI1520 is a PCI-to-CardBus controller that supports two independent card sockets compliant with the PC Card Standard 7.1. For 16 bit PC Card control the PCI1520 is fully register compatible with the Intel 82365L-DF PC Card interface controller through the ExCA register set. The ExCA registers can be accessed indirectly via PCI I/O access space or directly via PCI memory address space.

### 3.1 Address Mapping TPMC872 – PC Card 16 mode

The PCI1520 provides a window mechanism to link the PCI space to PC Card16 address space. Memory and I/O windows are programmable by the host software in the ExCA registers of the PCI1520.

**In PC Card16 mode the TPMC872 Version 1.0 is compatible to the TPMC871 Version 1.0, 2.0 and Version 3.0.**

#### 3.1.1 Memory Mapping

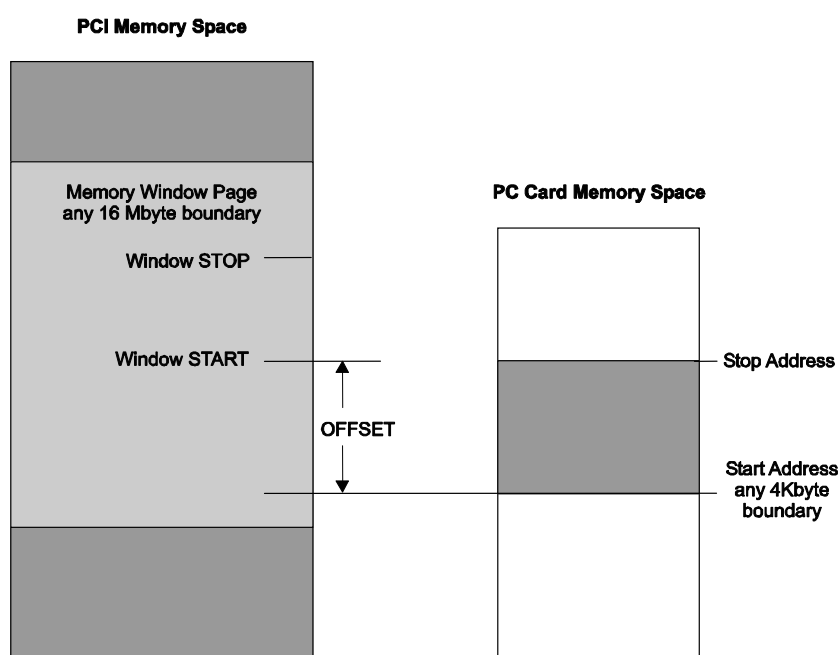

Figure 3-1 : PCI to PC Card memory mapping

To open a memory window, software must provide the PCI1520 with memory start address, memory stop address, PC Card memory offset and memory window page address.

PC Card memory is accessed only if the address window is enabled and if the memory address is located between start and stop address.

**The Memory Window Page Register is only accessible via the PCI memory address space.**

### 3.1.2 I/O Mapping

The 16 bit I/O card address space is accessed via 16 bit I/O addresses. The PC Card 16 I/O space is mapped to the lower 64kByte PCI I/O address space.

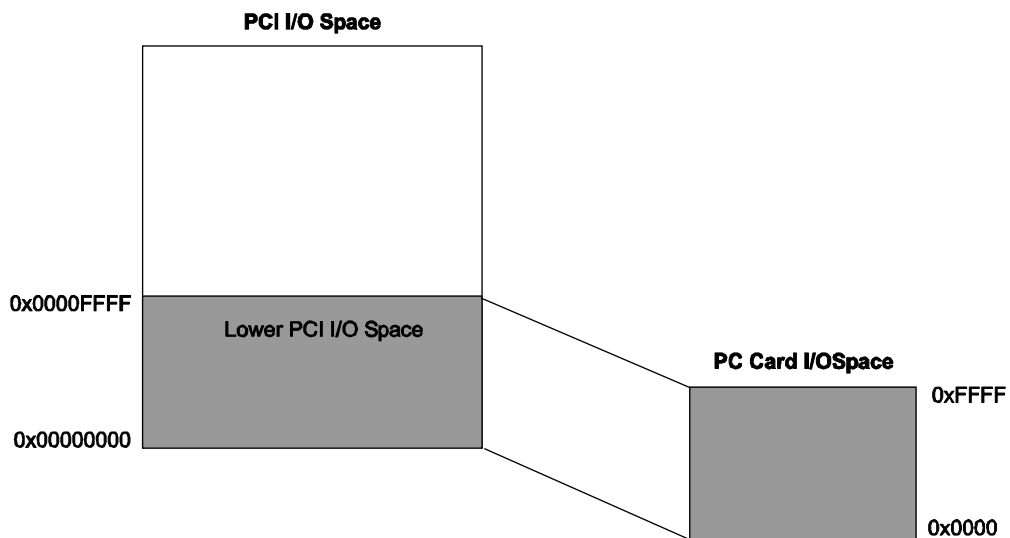

Figure 3-2 : PCI to PC Card I/O mapping

To open I/O window, software must provide the PCI1520 with I/O start address, I/O stop address, and I/O offset.

PC Card16 I/O is accessed only if the address window is enabled and if the I/O address is located between start and stop address.

**For detailed information about window mapping procedure and status / control registers please refer to the PCI1520 data sheet which is part of the TPMC872-ED Engineering Documentation.**

## 3.2 Address Mapping TPMC872 – CardBus mode

The PCI1520 provides a window mechanism to link the PCI space to 32 bit CardBus cards address spaces. Memory and I/O windows are programmable by the host software in the memory or I/O Base Registers in the PCI1520 configuration space. The PCI1520 offers two memory and two I/O windows per socket. The size of each window will be determined by host software via memory and I/O limit registers. The Base Address Registers will be initialized with the start addresses and the limit registers will be initialized with the upper address of the memory or I/O windows.

The CardBus card address space can be accessed via the CardBus base address registers, which are located in the PCI configuration space of the PCI1520.

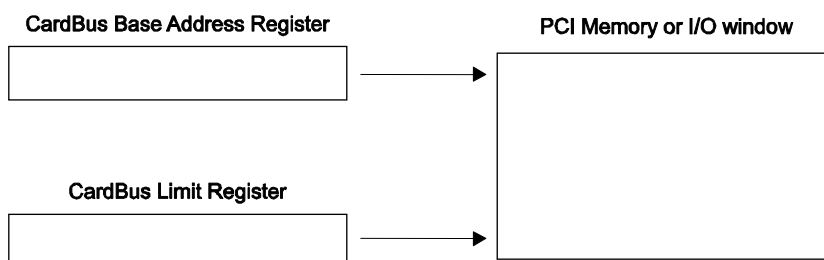

Figure 3-3 : CardBus window mechanism

The PCI1520 provides CardBus card status information via the CardBus Socket Register at configuration space offset 0x10. This address, which must be initialized by the device driver software, points to five 32 bit registers, which can be located anywhere in the PCI memory space at a 1Kbytes boundary at offset 0x00. Each Socket has a separate base address register to access the CardBus socket registers. The following socket registers are implemented in the PCI1520:

Register Name	Offset
Socket Event	0x00
Socket Mask	0x04
Socket Present State	0x08
Socket Force Event	0x0C
Socket Control	0x10
Reserved	0x14
Reserved	0x18
Reserved	0x1C
Socket Power Management	0x20

Figure 3-4 : Socket Registers implemented in PCI1520 (Function 0 and 1)

These registers may notify the device driver software that a card has been inserted, removed, and what supply voltage is needed to power the CardBus card properly etc.

Further information regarding the status of the CardBus interface can be obtained from the secondary status register at offset 0x16 in the PCI configuration space of the PCI1520. This register is very similar to the PCI Bus Status Register and provides information about parity errors, aborted transactions, CardBus system errors etc.

---

For detailed register description, please refer to PCI1520 data sheet which is part of the TPMC872-ED Engineering Documentation.

### **3.3 PCI Interrupts**

The multifunction pin 0 of the PC Card socket controller is used as the PCI interrupt INTA#. The PCI1520 provides a card status change interrupt which can notify the system of change in the PC Card battery voltage levels, PC Card insertion / removal detection, Ready/Busy# condition and functional status change for both sockets. These various interrupt sources of both PC Cards are individually programmable to INTA# via ExCA "Card Status Change Interrupt Configuration Register" at ExCA register offset 0x05.

## 4 PCI1520 PC Card Controller

### 4.1 PCI Configuration Registers (Functions 0 and 1)

#### 4.1.1 PCI Header of the TPMC872 Version 1.0

PCI CFG Register Address								PCI write able	Read after Reset (Hex-Value)	
	31	24	23	16	15	8	7			0
0x00	Device-ID				Vendor-ID				N	AC55104C
0x04	Status				Command				Y	02100000
0x08	Class Code						Revision ID		N	06070001
0x0C	BIST		Header Type		PCI Latency Timer		Cache line Size		Y[7:0]	00820000
0x10	CardBus Socket/ExCA Base Address								Y	00000000
0x14	Secondary Status				Reserved		Capability Pointer		N	020000A0
0x18	CardBus Latency Timer		Subordinate Bus Number		CardBus Bus Number		PCI Bus Number		Y	00000000
0x1C	CardBus Memory Base Register 0								Y	00000000
0x20	CardBus Memory Limit Register 0								Y	00000000
0x24	CardBus Memory Base Register 1								Y	00000000
0x28	CardBus Memory Limit Register 1								Y	00000000
0x2C	CardBus I/O Base Register 0								Y	00000000
0x30	CardBus I/O Limit Register 0								Y	00000000
0x34	CardBus I/O Base Register 1								Y	00000000
0x38	CardBus I/O Limit Register 1								Y	00000000
0x3C	Bridge Control Register				Interrupt Pin		Interrupt Line		Y	034001FF
0x40	Subsystem ID				Subsystem Vendor ID				Y	03681498
0x44	PC Card 16 I/F legacy mode base address								Y	00000001
0x48-0x7C	Reserved								N	00000000
0x80	System Control								Y	2844D061
0x84	Reserved								N	00000000
0x8C	Multifunction Routing								Y	00C01D02
0x90	Diagnostic		Device Control		Card Control		Retry Status		Y	616400C0
0x94	Reserved								Y	00000000
0x98	Reserved								Y	00000000
0x9C	Reserved								N	00000000
0xA0	Power Management Capabilities				Next Item Pointer		Capability ID		N	7E120001
0xA4	PM data		PMCSR bridge support		Power Management status/control				Y	00C00000
0xA8	General Purpose Event Enable				General Purpose Event Status				Y	00000000
0xAC	General Purpose Output				General Purpose Input				Y	00000000
0xB0	Serial Bus Control /Status		Serial Bus Slave Address		Serial Bus Index		Serial Bus Data		Y	00000000
0xB4-0xFC	Reserved								N	00000000

Figure 4-1 : PCI Configuration Register

## 4.2 Configuration EEPROM

The TPMC872 is equipped with an on board I<sup>2</sup>C EEPROM. After power-on or PCI reset, the following PCI Configuration Register of the PCI1520 PC Card controller will be initialized with hardware depended configuration data:

Register Name	Register Offset	EEPROM Offset	Value
Load EEPROM Data Flag	-	0x00	0x01
Command Register	PCI 0x04	0x01	0x00
Subsystem Vendor ID Register	PCI 0x40	0x02	0x1498
Subsystem ID Register	PCI 0x42	0x04	0x0368
PC Card 16-I/F LBAR	PCI 0x44	0x06	0x00000001
System Control Register	PCI 0x80	0x0A	0x28D061
Multifunction Routing Register	PCI 0x8C	0x0D	0x00C01D02
Retry Status Register	PCI 0x90	0x11	0xC0
Card Control Register	PCI 0x91	0x12	0x00
Device Control Register	PCI 0x92	0x13	0x64
Diagnostic Register	PCI 0x93	0x14	0x61
Power Management Capability	PCI 0xA2	0x15	0x7E
ExCA Identification and Revision	ExCA 0x00	0x16	0x84
Socket force Event (Function 0)	CB Socket + 0x0C (function 0)	0x17	0x00
Socket force Event (Function 1)	CB Socket + 0x0C (function 1)	0x18	0x00

Address	Offset															
	0x0	0x1	0x2	0x3	0x4	0x5	0x6	0x7	0x8	0x9	0xA	0xB	0xC	0xD	0xE	0xF
0x00	0x01	0x00	0x98	0x14	0x68	0x03	0x01	0x00	0x00	0x00	0x61	0xD0	0x28	0x02	0x1D	0xC0
0x10	0x00	0xC0	0x00	0x64	0x61	0x7E	0x84	0x00	0x00	0xFF	0xFF	0xFF	0xFF	0xFF	0xFF	0xFF

Figure 4-2 : Configuration EEPROM

## 4.3 ISA Interrupts

The TPMC872 provides a possibility to gain access to parallel or serialized ISA IRQ signals on board.

With the default EEPROM download configuration the PCI1520 is initialized to generate serial ISA IRQs on MFUNC3. For other IRQ configurations, the PCI1520 PC Card controller must be initialized through the controller's device driver. Interrupt signaling can be provided through the PCI1520 multifunction pins MFUNC3 and MFUNC6. MFUNC3 can be configured to function as serial or parallel ISA IRQ 2 to 15. MFUNC6 can be configured to function as parallel ISA IRQ 2 to 15. To enable the parallel ISA IRQs on these pins the following settings must be done by software:

Register	Offset	Required Value	ISA Routing
Multifunction routing	0x8C	Bits 27-24: 0x2 - 0xF	MFUNC6 is IRQ 2 -15
Multifunction routing	0x8C	Bits 15-12: 0x2 - 0xF	MFUNC3 is IRQ 2 -15
Device control	0x92	Bits 2-1: 0x01	Parallel ISA and PCI interrupts enabled
ExCA interrupt control	0x03	Bits 3-0: 0x3-0xF	IRQ 3-15 enabled

Figure 4-3 : ISA Interrupts

For further information please refer to the PCI1520 data sheet which is part of the TPMC872-ED Engineering Documentation.

The ISA IRQ signal of MFUNC3 can be accessed in several ways. One option is to route the signal via a 0Ohm resistor to the PMC connector P11 Pin10. Alternatively, the signal can be accessed on the flipside of the TPMC872. The following figure shows where the ISA IRQ signal of MFUNC3 can be accessed on the flipside of the TPMC872:

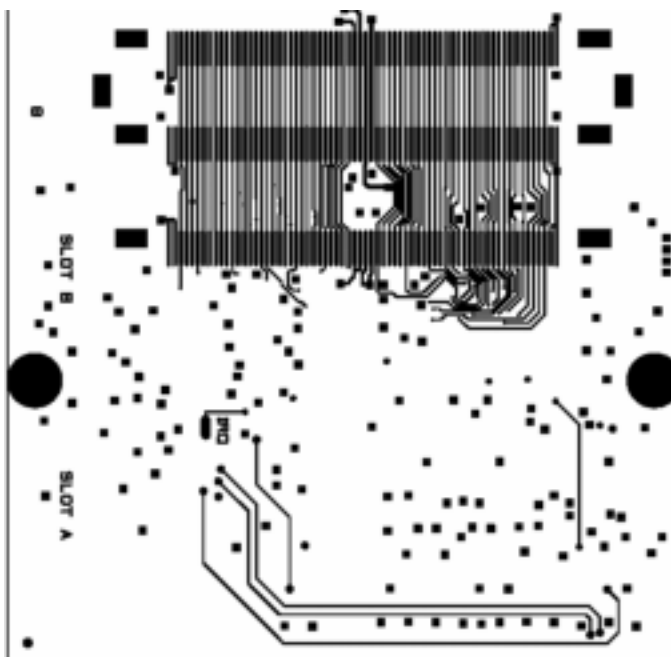

Figure 4-4 : ISA IRQ pad location

---

## 4.4 Initialization for CardBus mode

The TPMC872 is initialized for PC Card16 mode per default. If 32 bit CardBus operation is wanted, a software device driver should perform the following initialization steps:

- The CardBus Latency Timer Register at offset 0x1B in the PCI Configuration space should be set to a value of 0x20.
- A Memory and/or the I/O Base Address Register must be written with a valid 32 bit window start address.
- A Memory and/or I/O Limit Register must be written with a valid 32 bit upper window address.